

S600

Compressed Air Purity Analyzer (Portable Version)



Please read the instruction manual before using the instrument!
Attention: Input pressure range 0.3 ... 1.5 MPa

ALL IN ONE
Dew point, particle and oil vapor



Smart measurement — save precious time



By connecting a LTE/4G modem to the designated USB port, S600 can be monitored remotely through S4A software

S600 FEATURES



ALL IN ONE
Dew point, particle and oil vapor



PRECISION
Accurate measurements



TOUCH SCREEN
Easy operation

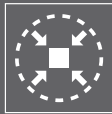

COMPACT DESIGN
Makes it unique



PORTABLE
Can be carried with one hand



USB INTERFACE
For data transfer

S600 BENEFITS

- All-in-one device measures Particle concentration, dew point and oil vapor
- Measures additionally the temperature and pressure
- Software guided measurement makes it easy to generate reliable results
- Report generator creates PDFs for audits
- Ultra portable and compact design
- Compressed air connection via 6 mm tube
- Integrated data logger saves data for later analysis
- Dew point measurement from -100... +20 °C Td
- Oil vapor measurement from 0.003... 10.000 mg/m³
- Particle measurement from 0.1 < d ≤ 5.0 μm & d > 5.0 μm

ISO 8573 compliant purity quantifications of compressed air systems are bound to time-consuming installations and long-lasting test runs ... It's time for a revolution: The S600 is unlike its competition.

It combines the latest sensor technology, software-guided measurements and a time-saving setup into a handy, touch-screen controlled multi-tool. With our S600 you will finish measurement runs in much less time than with your traditional method, after that you don't ever want to leave your new comfort zone again. Trust us.

S600 DIMENSIONS

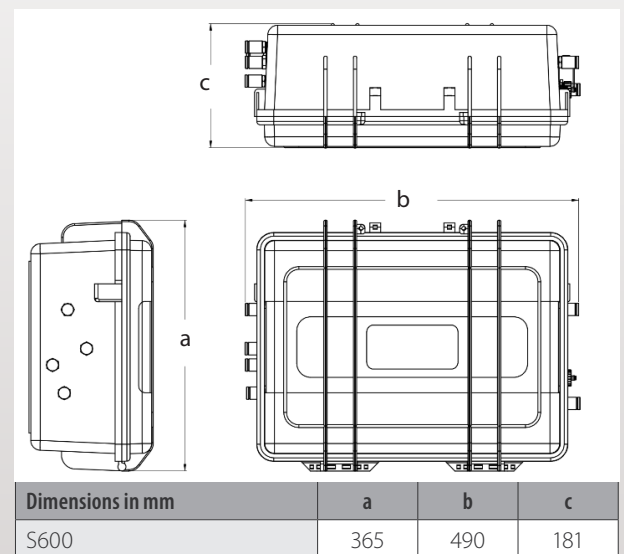

S600 APPLICATIONS

The S600 is the portable multi-tool for compressed air purity measurements. It measures, records and validates quality parameters like particles, dew point, oil vapor contents, temperature and the pressure of compressed air systems.

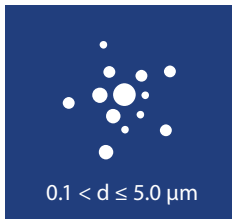

PARTICLE CONCENTRATION MEASUREMENT

- + Measurement methods according to ISO 8573 standards (together with isokinetic sampling device)
- + Latest laser detection technology
- + Smallest particle size 50 % per ISO 21501-4, bigger sizes 100 % per ISO 21501-4

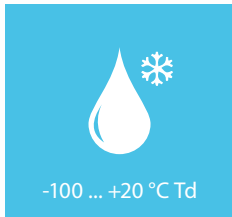

DEW POINT MEASUREMENT

- + Large ranges thanks to the unique multiple sensor technology
- + Long-term stable and well-proven measurement methods
- + High precision with an accuracy of ±2 °C Td

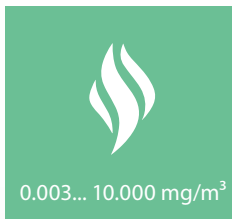

OIL VAPOR MEASUREMENT

- + Latest photoionisation detector (PID) with self-calibration
- + Wide range of oil vapor concentrations
- + High precision with 5 % of reading ± 0.003 mg/m³ accuracy

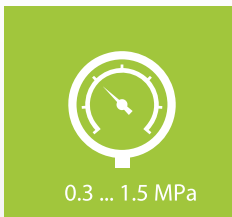

PRESSURE MEASUREMENT

- + State of the art sensor technology
- + Additional quality data about the compressed air system

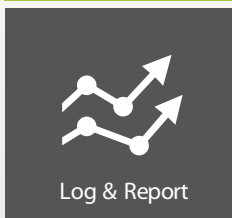

PLUG & PLAY MEASUREMENTS WITH A TOUCH

- + Integrated data logger records all channels in parallel for later analysis
- + 5" touchscreen allows you to interact with the device on site. There is no need for a PC to manage the device.

For particle measurements according to ISO 8573 an isokinetic sampling tube has been designed. This optional equipment enables you to monitor and adjust the air flow of the particle measurement to ensure the correct isokinetic sampling.



S600 with the isokinetic sampler attached

S600 TECHNICAL DATA

General Specifications	
Measuring unit	5" colour touchscreen with data logger, guided measurement and report generator function. All combined and integrated with the multiple sensor system.
Process connection	Micro quick connector, full passthrough, male (1.5 m hose with coupling included)
Operating pressure	0.3 ... 1.5 MPa
Ambient temperature	0 ... +50 °C
Storage & Transport temperature	-10 ... + 70 °C
Medium	Compressed Air, Nitrogen N ₂ , Carbon dioxide CO ₂ (software setting)
Medium temperature	0 ... + 40 °C
Medium humidity	< 40 % rH, no condensation
Reference settings	ISO1217 20 °C 1000 mbar
UV lamp lifetime (oil vapor sensor)	1 year or 6000 working hours, whichever comes first
Power supply	Mains supply adapter (AC/DC) Input: 100 ... 240 VAC, 50/60 Hz, 1.4 A Output: 24 VDC, 2.5 A, 60 W max.
Data logger	100 mio. values, Integrated report generator for PDF export
Measured values	Temperature, Pressure, Oil vapor, Dew point, Particle concentration
Interface	USB, Ethernet (Modbus/TCP)
Display	Touchscreen, Size: 5", Resolution: 800 x 480 px
Dew point sensor	Dual-sensor technology (QCM & Polymer)
Particle sensor	Laser optical detection
Oil vapor sensor	PID (Photoionisation detector)
Measurement duration	min. 35 minutes (no upper limit)
Sampling rate	1 sample / sec.
Classification	IP54 (cover lid closed)
Casing material	PC + ABS, Al alloy
Weight	9.8 kg
EMC	IEC 61326-1
Measurement Specifications	
Measurement range Particle counter	0.1 < d ≤ 0.5 µm ; 0.5 < d ≤ 1.0 µm ; 1.0 < d ≤ 5.0 µm ; d > 5.0 µm
Measurement range Dew point sensor	-100 ... +20 °C Td
Measurement range Oil vapor sensor	0.003 ... 10.000 mg/m ³
Detection limit oil vapor sensor	0.003 mg/m ³
Resolution oil vapor sensor	0.001 mg/m ³
Accuracy Particle measurement	50 % @ 0.1 < d ≤ 0.15 µm 100 % @ d > 0.15 µm per ISO 21501-4
Accuracy Dew point measurement	±2 °C Td
Accuracy Oil vapor measurement	5 % of value ± 0.003 mg/m ³
General Specifications Isokinetic sampling device	
Measuring unit	Sampling pipe with integrated isokinetic sampling tube, flow regulation and control by integrated flow sensor, to be used for particle measurements according to ISO8573
Process connection	Micro quick connector, full passthrough, male (1.5 m hose with coupling and connection hoses to S600 included)
Operating pressure	0.3 ... 1.5 MPa
Ambient temperature	0 ... +50 °C
Storage & Transport temperature	-10 ... +70 °C
Flow sensor	Thermal mass flow, only for isokinetic flow setup, no system-flow measurement
Interface	Communication interface for S600, cable included, M8
Accuracy	3 % o. RDG
Purge flow	Regulated by needle valve, setup guided by S600

S600 ORDERING



Visit our website or e-mail us:
www.suto-itec.com
sales@suto-itec.com

Please use the following table to assist in placing your order with our sales staff.

S600 Compressed Air Purity Analyzer (Portable Version)	
Order No.	Description
P560 0600	<p>S600 Portable compressed air analyser</p> <p>Touch screen interface, data logger, guided measurement, PDF report generator, USB port and Ethernet port with Modbus/TCP</p> <p>Particle d: $0.1 < d \leq 0.5, \mu\text{m}$ $0.5 < d \leq 1.0, \mu\text{m}$ $1.0 < d \leq 5.0, \mu\text{m}$ $d > 5.0, \mu\text{m}$</p> <p>Dew point: $-100 \dots +20 \text{ }^\circ\text{C Td}$</p> <p>Oil vapor: $0.003 \dots 10.000 \text{ mg/m}^3$</p> <p>Including:</p> <ul style="list-style-type: none"> - Portable compressed air analyzer in a hand carry case with handle and shoulder belt - USB OTG memory stick - Purge filter for pre-measurement (test kit) - Power supply, 230 VAC / 24 VDC 50/60 Hz - 2 x Connection hose 1.5 m, one end quick coupling, one end compressed air coupling - Certificate of calibration - Operation and instruction manual
A554 0600	<p>Isokinetic sampling device for particle measurement according to ISO 8573</p> <p>Including:</p> <ul style="list-style-type: none"> - Isokinetic sampling pipe - Flow sensor mounted on pipe - Certificate of calibration - Connection cable to S600 - Connection hose 150 mm, both ends quick coupling - Connection hose 700 mm, both ends quick coupling - Connection hose 1.5 m, one end quick coupling, one end compressed air coupling - Transport case to carry the device, hoses and cables
A1670	<p>USB 4G dongle for S551/S600, including S4A software</p>